

[staffa fissaggio tubi per PTR | pipe fixing brackets for PTR]

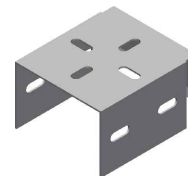
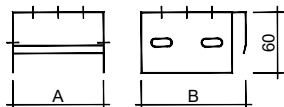

ELEMENTO | ELEMENT

CODICE | CODE

| Descr. | A | B | Th | HDG | AISI 304 | AISI 316 |
|-----------------------|-----|-----|-----|----------|----------|----------|
| SSFT-1 (3/4"- 1.1/2") | 90 | 105 | 1,5 | SOFT0001 | * | * |
| SSFT-2 (2"- 4") | 170 | 185 | 1,5 | SOFT0002 | * | * |

* A richiesta - On request

[staffa fissaggio tubi per PFLR | pipe fixing brackets for PFLR]

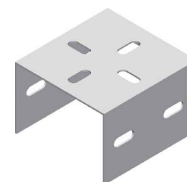
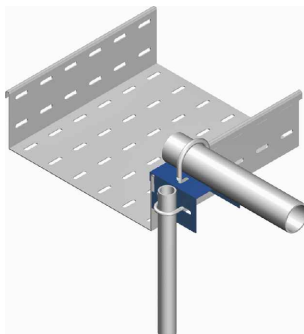
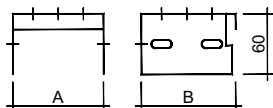

ELEMENTO | ELEMENT

CODICE | CODE

| Descr. | A | B | Th | HDG | AISI 304 | AISI 316 |
|-----------------------|-----|-----|-----|----------|----------|----------|
| SSFT-3 (3/4"- 1.1/2") | 90 | 95 | 1,5 | SOFT0003 | * | * |
| SSFT-4 (2"- 4") | 170 | 175 | 1,5 | SOFT0004 | * | * |

* A richiesta - On request

[staffa fissaggio tubi per PTR/PFL | pipe fixing brackets for PTR/PFL]

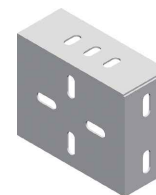
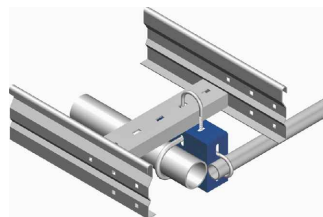
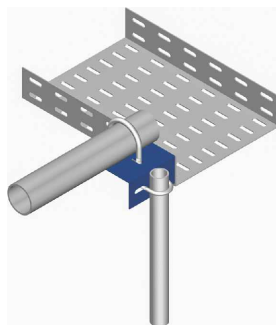
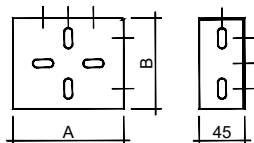

ELEMENTO | ELEMENT

CODICE | CODE

| Descr. | A | B | Th | HDG | AISI 304 | AISI 316 |
|-----------------------|-----|-----|-----|----------|----------|----------|
| SIFT-1 (3/4"- 1.1/2") | 110 | 90 | 1,5 | SOFT0011 | * | * |
| SIFT-2 (2"- 4") | 170 | 170 | 1,5 | SOFT0012 | * | * |

* A richiesta - On request